

# ***Brandt***

**EN INSTRUCTION FOR USE**

Fridge

**SA3353E  
SA2363E**



# Fridge

Thank you for your confidence in buying our appliance and congratulations on the excellent choice. We hope it will successfully serve its purpose for many years.

Fridge (hereinafter: the appliance) is used in households for storage of fresh food at temperatures above 0°C.

<b>Before first operation .....</b>	<b>3</b>
<b>Environmental protection .....</b>	<b>4</b>
<b>Description of the appliance .....</b>	<b>4</b>
<b>Installation and connections .....</b>	<b>5</b>
<b>Changing the Direction of Opening the Door .....</b>	<b>7</b>
<b>Control panel - appliance with mechanical regulation .....</b>	<b>7</b>
<b>Refrigerator accessories .....</b>	<b>8</b>
<b>Storage of food in the refrigerator .....</b>	<b>9</b>
<b>Storing food in the ZERO'N'FRESH compartment.....</b>	<b>10</b>
<b>Food safety .....</b>	<b>12</b>
<b>Defrosting the appliance.....</b>	<b>13</b>
<b>Cleaning the appliance .....</b>	<b>13</b>
<b>Troubleshooting guide.....</b>	<b>14</b>
<b>Noise level.....</b>	<b>15</b>

## Before first operation

- This appliance is not intended for use by persons (including children) with reduced physical, sensory or mental capabilities, or lack of experience and knowledge, unless they have been given supervision or instruction concerning use of the appliance by a person responsible for their safety.
- Before connecting the appliance read these instructions carefully. They describe the appliance and provide instructions for its safe and correct use. The instructions are prepared for different types and models of the appliance so they may contain descriptions of functions and components your appliance may not have.
- Remove the wrapping protecting the appliance during transport.
- Wrappings contain environmentally friendly materials which can be recycled, recovered or disposed off without threat to the environment.
- On the door corners (on freestanding appliances) or on the housing of the appliances (on built-in appliances) the spacers are installed, which should be removed and replaced with the attached spacer-plugs.
- Before connecting the appliance to the mains supply, leave it in upright position for about 2 hours. This will reduce possibility of malfunctions in the cooling system resulting from prior transport and handling.
- The appliance must be connected to the mains supply in accordance with the standing regulations and local requirements.
- The appliance must not be used in open air or exposed to weather precipitation.
- Always disconnect the appliance from power supply (pull the power cord from wall socket) before cleaning and before replacing the light bulb.
- If the power supply cord is damaged, in order to avoid hazard it must be replaced by the service or by qualified personnel.
- In case of longer disuse first turn the appliance off with the ON/OFF button and disconnect it from mains supply. Empty the appliance, clean the interior and leave the door ajar.
- For the protection of environment deliver the obsolete appliance to the authorized scrap appliance dealers.
- Never let the children play with the appliance.
- Self closing shear door hinge pulls the door to the cabinet just before closing, thereby preventing the door to remain ajar. Equally it limits the door opening angle and prevents damage to adjacent elements.
- Rating plate with basic information is located in the interior of the appliance. If the sticker plate is not suitable for your language, replace it with the attached one.
- **Warning:** Ventilation slots on the appliance or built-in element should always be kept clean and unobstructed.
- **Warning:** Do not use any mechanical accessories when thawing the refrigerator, except for those explicitly recommended by the manufacturer.
- **Warning:** To prevent any pollution be careful not to damage the insulation or refrigeration tubes at the rear wall during the installation, cleaning and disposal of the appliance.
- **Warning:** Do not use any electrical devices inside the appliance, except for those explicitly recommended by the manufacturer.

## Environmental protection

This appliance's packaging material is recyclable. Help recycle it and protect the environment by dropping it off in the municipal receptacles provided for this purpose.



**Your appliance also contains a great amount of recyclable material. It is marked with this label to indicate that in countries that are a members of the European Union the used appliances should not be mixed with other waste. This way, the appliance recycling organised by your manufacturer will be done under the best possible conditions, in compliance with European Directive 2002/96/EC on Waste Electrical and Electronic Equipment. Contact your town hall or your retailer for the used appliance collection points closest to your home.**

**We thank you doing your part to protect the environment.**

## Description of the appliance

Interior equipment of the appliance will typically vary according to the specific model.

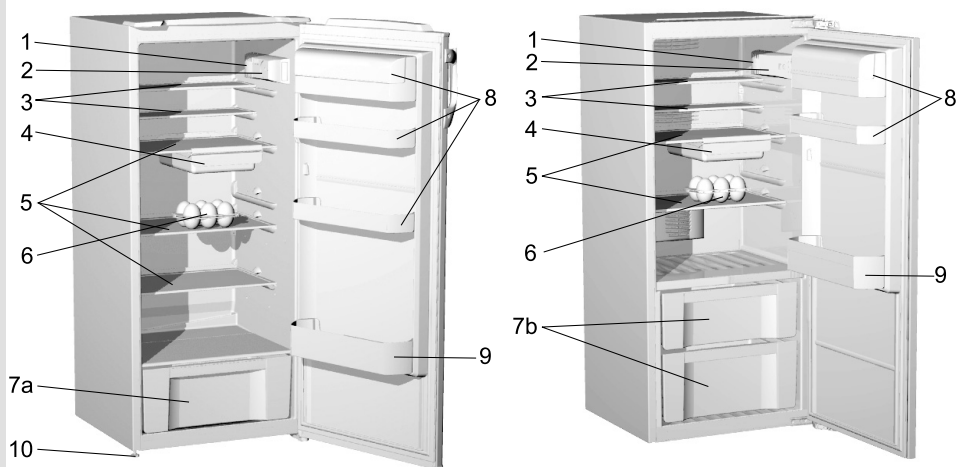

- 1 Interior light
- 2 Control panel
- 3 Adjustable glass shelves
- 4 Removable snack tray
- 5 Pull-out glass shelf (adjustable height)
- 6 Foldable egg rack  
(closed - 6 eggs, open - 12 eggs)
- 7a Storage compartment

- 7b ZERO'N'FRESH pan
- 8 Refrigerator door pans  
(options: deep, shallow; covered or no cover)
- 9 Door bottle rack with safety holder
- 10 Legs

# Installation and connections

## Selecting the location

- Place the appliance in dry and well aired room. The appliance operates best at temperature ranges indicated in the chart below. Relevant class of the appliance is indicated on the rating plate.

Class	Ambient temperature
SN (subnormal)	from + 10°C to + 32°C
N (normal)	from + 16°C to + 32°C
ST (subtropical)	from + 16°C to + 38°C
T (tropical)	from + 16°C to + 43°C

## Positioning the appliance

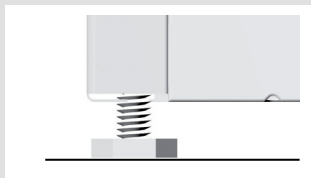

Positioning the appliance requires two persons in order to avoid injuries or damage to the appliance.

- Place the appliance flatly and firmly on a solid base. The appliance is fitted with adjustable feet on the front side, used to level the appliance (certain models only).
- Avoid exposing the appliance to direct sunlight or heat sources. If this is not feasible, install insulation plate between the appliance and adjacent heat source.
- The appliance may stand independently or you may incorporate it into the kitchen cabinet. Be sure to leave enough space for cooling of condenser (distance from the wall or the opening should be 200 cm<sup>2</sup>). Distance to the cabinet above the appliance should be at least 5 cm. After the installation, the appliance mains plug should be accessible!

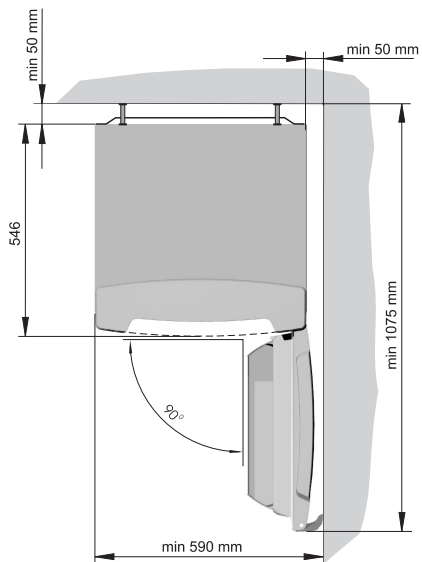

### **Connecting to power supply**

- The appliance is fitted with spacers to be mounted on the top edge of the condenser. They prevent the rear of the appliance to be pushed too close to the wall. Spacers are fabricated universally regarding the different distance of the condenser from the cabinet, so make sure to position them properly.

- Use the power cord to connect the appliance to the mains power. Wall outlet must be fitted with ground terminal (safety socket). Required nominal voltage and frequency are indicated on the relevant label or rating plate of the appliance.
- Mains power connection and grounding must be made in line with standing regulations and local requirements.

The appliance is able to accommodate minor temporary voltage tolerances, but they may not exceed -6% to +6%.

Your appliance is compliant with European Directives as well as their modifications.

# Changing the Direction of Opening the Door

## Freestanding appliance

Necessary tools: ring spanner No.8, screwdriver, torque 25

Tilt the appliance so that the bottom hinge can be unscrewed and proceed with disassembling as shown in the Figure 3. Then fix the assembly parts again in the opposite turn. Use the attached opposite hinge insert piece. The door should be ajar before the middle (upper) hinge is attached. Use the bungs, which have been pulled out, on the opposite side. Check the door seal. In case that it does not rest well, take it off and turn it by 180°.

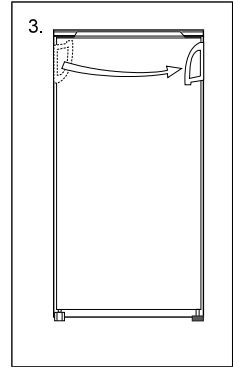
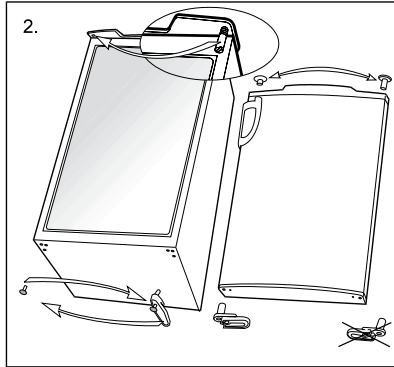
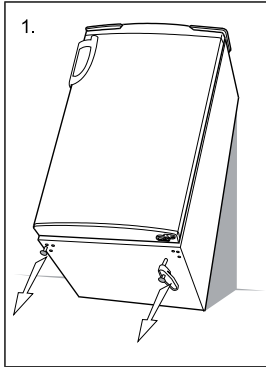

# Control panel - appliance with mechanical regulation

## ON/OFF button

The appliance is switched on/off by turning the temperature selector (see Fig.) to any position from 0 to 7.

The appliance operation is controlled by turning the thermostat (temperature selecting button) located within the refrigerator cabinet from the position STOP (0) to the position 7 and back.

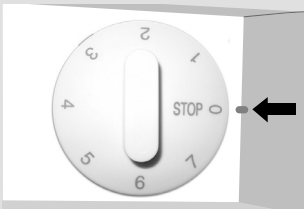

## Temperature setting

- The higher the position of the temperature selector (towards position 7) the lower is the temperature (cooler) within the cabinet of the appliance. Interior temperature in the refrigerator may even fall below 0°C. Higher position settings are to be used on in case of recommended low cooling temperature. In case of standard ambient temperature we recommend the medium setting.
- Change in the ambient temperature affects the temperature of the appliance, so the position of the temperature selector should be adjusted accordingly.
- In the STOP (0) position the appliance is switched off (cooling system is off). However, the appliance is still powered (light bulb is turned on if you open the refrigerator door).

# Refrigerator accessories

**(Equipment depends on the model)**

## **Shelf**

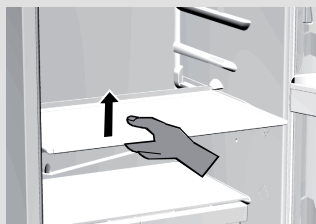

- Shelves can be optionally placed on the guides inside the appliance. To remove the shelf, first slide it out as far as the guide allows it, then slightly lift it up and pull it out. Quickly perishable food should be stored on the back i.e. the coldest part of the shelves.

## **Adjustable glass shelf**

If you need space to store higher objects (bottles, jars, jugs) in the refrigerator you can remove the front part of the shelf, relocate it to a lower level, and obtain the required space.

## **Horizontal bottle rack**

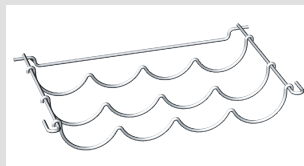

It is protected against accidental slide out.

The rack can only be pulled out when it is empty. Lift the back part of the rack and pull it towards yourself.

The rack should be placed in the appliance in such way to allow unobstructed door closing.

Maximum capacity is 9 bottles of 0,75 l, or 13 kg of total mass.

## **Vegetable crisp pan**

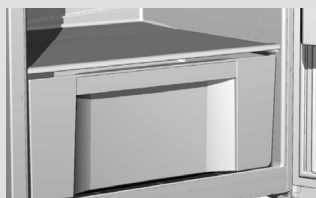

- Crisp tray below the glass shelf at the bottom of the refrigerator is used for storage of fruit and vegetables. It retains the right level of moisture and prevents drying out.

## **Refrigerator door lining**

- The refrigerator door lining consists of various shelves or holders used for storing cheese, butter, eggs, yogurt, and a stock of other smaller packages, tubes, cans etc. The bottom shelf is used for storing bottles.

## **Fan**

- Fan fixed under the ceiling or hidden behind the rear refrigerator panel or within the freezer compartment improves even distribution of temperature and decreases dew upon storage racks.



### **Removable snack tray**

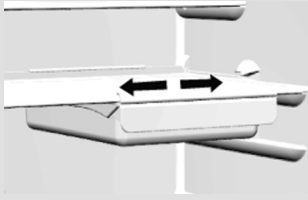

### **Recommended distribution of food**

The tray is especially handy for cold cuts, cheese, etc ...  
The drawer is pulled out by lifting the front part slightly and then pulling out. The handle may be moved sideways along with the drawer.

#### **Refrigerator compartments:**

- **top section:** canned food, bread, wine, cake, etc.
- **middle section:** dairy products, readymade food, desserts, juices, beer, TV-dinners, etc.
- **bottom section:** meat, meat products, delicatessen, etc.
- **vegetable drawer:** fresh fruit, vegetables, salads, etc. In appliances without the ZERO'N'FRESH compartment, root vegetables, potatoes, onions, garlic, tomatoes, tropical fruit, sauerkraut, turnip, etc. should also be stored in the vegetable drawer.
- **ZERO'N'FRESH COMPARTMENT:** fresh meat, meat products, fish, other seafood (shellfish), dairy products, salad, fruit, vegetables, mayonnaise, sauces, etc.

#### **Refrigerator door lining compartments:**

- **top/middle section:** eggs, butter, cheese, ...
- **bottom section:** beverages, cans, bottles, ...

## **Storage of food in the refrigerator**

### **Important precautions and hints**

- Proper use of the appliance, adequately packed food, correct temperature and hygienic precautions produce substantial impact on the quality of stored food.
- Always respect the best before date, printed on the packaging.
- Food to be stored in the refrigerator should be properly packed as to prevent emission and/or reception of moisture and odors.
- Never store inflammable, volatile or explosive substances.
- Beverages with high alcohol percentage shall be stored in tightly sealed bottles in vertical position.
- Some organic solutions like volatile oils in lemon or orange peel, acids in butter etc. can cause damage in prolonged contact with plastic surfaces or gaskets for longer period of time they can cause accelerated aging of the plastic material.
- Unpleasant odor inside the refrigerator is a sign that something is wrong with food or that your refrigerator needs cleaning (see chapter Cleaning).

- If you plan a longer absence, make sure you removed quickly perishable articles of food from the appliance before you leave.

## Storage periods

### Recommended periods of storing fresh food in the refrigerator

Food	Storage period
eggs, marinades, smoked meat,	up to 10 days
cheese	up to 10 days
carrots, etc...	up to 8 days
butter	up to 7 days
cake, fruit, TV-dinner dishes, raw chunks of meat	up to 2 days
fish, raw minced meat, seafood	up to 1 day

## Storing food in the ZERO'N'FRESH compartment

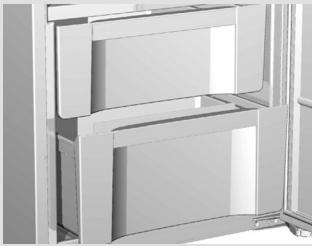

The ZERO'N'FRESH drawer enables storing a variety of fresh food for approximately three times as long as in a conventional refrigerator. The food will remain fresh and retain its flavor and nutrients for a longer period of time.

Storing food in the ZERO'N'FRESH drawer prevents decay and loss of mass; thus, fruit and vegetables are more fresh and natural. Storage temperature is preset to approximately 0 °C.

The temperature may vary from -2°C to +3°C, depending on the temperature in the refrigerator. If the temperature of the environment where the appliance is installed is lower than 16°C, we recommend setting the refrigerator compartment temperature to 4°C or less. For optimum operation, the drawer should be tightly closed.

- When you buy food check its freshness: quality and durability of food depends on it.
- Store your food in closed containers or appropriate packaging to prevent it from emitting or receiving odours and moisture.
- Approximately 30-60 minutes prior use remove food from the drawer to let its aroma and taste develop at ambient temperature.
- Food sensitive to low temperatures is **not suitable** for storage in the ZERO'N'FRESH drawer: pineapple, avocado, bananas, olives, potato, eggplant, cucumber, beans, bell pepper, melons, water melons, pumpkins,...

**Approximate  
storage time in the  
ZERO'N'FRESH\* drawer**

Type of food	Time
Sausages, cold cuts, beef, pork, venison, raw meat	up to 7 days
poultry	up to 5 days
fish	up to 4 days
seafood	up to 3 days
<b>Vegetables:</b>	
cabbage, garlic, carrots	up to 180 days
celery, herbs	up to 30 days
lettuce, cauliflower, radicchio, rhubarb	up to 21 days
broccoli, asparagus, savoy, Chinese cabbage kohlrabi, radish	up to 14 days
onions, mushrooms, spinach, peas	up to 7 days
<b>Fruit:</b>	
apples	up to 180 days
pears, kiwi	up to 120 days
grapes, quince	up to 90 days
peaches	up to 30 days
blackcurrant, gooseberry, plums	up to 21 days
apricots, blueberries, cherries	up to 14 days
raspberries, strawberries	up to 3-5 days
<b>Other:</b>	
milk	up to 7 days
butter	up to 30 days
cheese	up to 30 days

\* depending on quality and freshness of food

# Food safety

## Temperature Indicator



The temperature indicator, situated in the coolest part of refrigerator, helps to control correct temperatures of the appliance. Adequate temperature is indicated with **O.K.** mark. If this mark does not show, the temperature of this compartment is too high. Use the thermostat to reduce the temperature in a particular compartment (see chapter "Control of the appliance"). Do not change the setting too often; before temperature checking or when setting it anew, please, wait for 12 hours at least.

**Remark!** After the appliance has been loaded with fresh food, or when the door is open too frequently or for a too long time, the OK mark will not be visible. The coolest area of refrigerator, which appears immediately above the shelf covering the crisper pan, is about 20 cm in height.

## Food Arranging

Compartment	Food
Freezing compartment 	Ice, frozen food, fresh food intended for freezing...
<b>Refrigerator areas:</b>	
<b>Cold area</b>	
Crisper pan Top shelves Door compartments	Fresh fruits, vegetable,... Butter, cheese, eggs, yoghourth, beverages,...
<b>Colder area</b>	
Middle shelves	Products of milk, sweets, prepared dishes (e.g. sauces and other fatty dishes), soft & fresh cheese, delicatessen, sweets,...
<b>The Coldest area</b>	
Above the shelf covering the crisper pan	Meat (especially poultry, venison, fish), delicatessen or other prepared food, salads, short pastry based on eggs or cream, fresh puff pastry, spongecake, yeast dough for pizzas, fresh products and cheeses made of uncooked fresh milk, vegetables ready and adequately wrapped or all fresh products, the consumption date of which is conditioned by a saving temperature which must be lower or equal to +4°C. Max. storing time: 1-2 days

### Remark:

Bananas, potato, garlic and onion are not kept in the refrigerator. Fermented cheeses are not kept in refrigerator, except if we wish to stop its ripening. They must be well wrapped.

## Defrosting the appliance

### *Automatic defrosting of the refrigerator*

Refrigerator needs no special defrosting procedure, because ice deposited at the inner back wall is defrosted automatically. Ice deposited on the inner back wall during the compressor operation is defrosted when the compressor stops operating, and condensed water drops are drained through the outlet in the inner back wall into the drain pan situated above the compressor where it evaporates. In case you should notice excessive ice formation at the rear refrigerator panel (3-5 mm thick), switch the appliance off and thaw it manually.

## Cleaning the appliance

**Prior any cleaning attempt disconnect the appliance from the mains** (see the control chapter for ON/OFF function), and pull the power cord from the mains wall outlet.

Special antibacterial protection in top layer of inner walls prevents multiplication of bacteria and maintains the interior clean and germ free.

Make sure to remove traces of any cleansing agents you had been using.

- Clean the **exterior** of the appliance with water and liquid detergent.
- Do not use abrasive or aggressive agents (such as stainless steel cleansers) for cleaning of plastic and coated surfaces as you can damage them.
- Clean **coated and/or aluminum surfaces** with soft cloth and alcohol based cleansing agent (for example glass cleaners).
- Wash the **interior** of the appliance with liquid detergent and lukewarm water, mixed with a little vinegar.
- Containers, shelves, and drawers with a decorative profile (metallic appearance) are not dishwasher safe! They can only be cleaned with a dissolved liquid detergent and a soft cloth. Do not rub them!
- Appliances without the ZERO'N'FRESH drawer: cooling surface on the rear wall is periodically defrosted. The drain groove and the outlet through which the water is discharged should not be clogged (food residues).

Check them regularly and clean as required (e.g. with a plastic straw).

- The **condenser** on the rear wall must always be clean and free of dust or kitchen fumes deposits, therefore clean the dust periodically with non-metallic brush or vacuum cleaner.

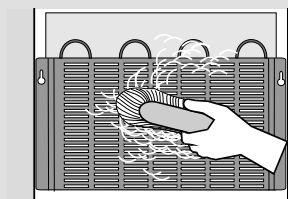
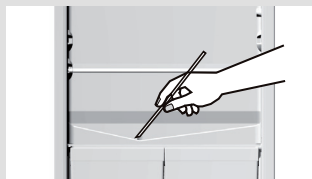

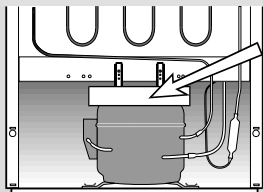

- Clean also the **drip pan** above the compressor. If you removed the pan, please make sure you replace it to the same position, and check that it is in completely horizontal position!

## Troubleshooting guide

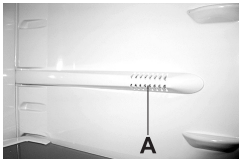
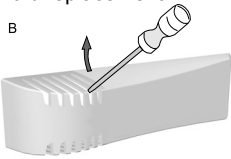
Fault:	Cause/Remedy
The appliance does not operate after connection to the mains:	<ul style="list-style-type: none"> <li>• Check if there is power in the socket and if the appliance is switched on.</li> </ul>
Cooling system operates continuously without intermittent stoppages: 	<ul style="list-style-type: none"> <li>• Ambient temperature too high.</li> <li>• Frequent opening of the door, door open too long.</li> <li>• Door not closed properly (particle between door gasket, sagged door, check gasket sealing, etc...).</li> <li>• Excessive quantity of fresh food inserted at once.</li> <li>• Refrigerator probe (A) is clogged with fresh food. Relocate the food to provide air circulation around the probe (certain models only).</li> <li>• Check air circulation for sufficient cooling of the compressor, and clean the condenser.</li> </ul>
Excessive ice formation at the rear interior wall of the freezer:	<ul style="list-style-type: none"> <li>• Frequent opening of the door, door open too long.</li> <li>• Inserting hot food in the freezer.</li> <li>• Food or dish is touching the rear interior panel of the refrigerator.</li> <li>• Bad door sealing; clean or replace the gasket if dirty or damaged.</li> </ul>
Water dripping from the appliance:	<ul style="list-style-type: none"> <li>• Drain outlet is clogged, drain water drips past the collection groove.</li> <li>• Clean the clogged outlet using plastic straw.</li> <li>• Thaw thick ice deposits manually (see chapter Defrosting).</li> </ul>
Bulb replacement: 	<ul style="list-style-type: none"> <li>• Before replacing the light bulb, disconnect the appliance from the power supply (pull the power cord from the wall socket). B – Insert the screwdriver into the cover slot, lift it and remove the cover.</li> <li>• Replace the bulb with the equivalent new bulb (E 14, same voltage as the original one) and replace the cover back to its position.</li> <li>• Don't forget: the old bulb does not belong to organic waste.</li> <li>• Light bulb is consumption material and is not covered by the warranty!</li> </ul>
Helpful hints	<ul style="list-style-type: none"> <li>• If none of the above proves effective and you can not remove the fault yourself, disconnect the appliance from the mains ( see chapter regarding the ON/OFF function), pull the power cord from the wall socket, wait for approximately 10 minutes and reconnect the appliance. If the fault persists call the nearest service center and tell them the information from the rating plate: type of appliance, model and serial number, located inside the appliance.</li> </ul>

The refrigerator – freezer appliances are cooled by the refrigeration system with a compressor (assisted by fan in certain models) whose operation may produce certain noise. The level of such noise depends upon the location, correct use and age of the appliance.

- **After starting the appliance**, the operation of the compressor (the refrigerant flow) may be somewhat louder. This does not mean that something is wrong with the appliance, neither has it any influence on the lifetime of the appliance. Gradually the noise is reduced and eventually subsides.
- Sometimes the appliance produces **unusual and stronger noise** which is rather unusual for the appliance. This noise is often the consequence of inadequate positioning of the appliance:
  - The appliance should be placed and leveled firmly on solid base.
  - It should not touch the wall or adjacent kitchen units standing next to it.
  - Check whether the accessories in the interior of the appliance are placed correctly in their positions; also check the bottles, tins and other vessels that might touch each other and rattle.

THE MANUFACTURER RESERVES THE RIGHT TO ALTER THE SPECIFICATIONS WITH NO IMPACT TO THE FUNCTIONAL OPERATION OF THE APPLIANCE.

### TECHNICAL ASSISTANCE DEPARTMENT

If you have already performed the indicated checks and your problem still persists, **DO NOT ATTEMPT TO MAKE ANY REPAIRS YOURSELF**. Contact your nearest Technical Assistance Department.

Any work on your appliance must be performed by a Brandt accredited qualified professional.

When you call, please mention the complete reference for your machine (model, type, serial number): this information is provided on your guarantee certificate and the information plate on your appliance.

### ORIGINAL SPARE PARTS



When any maintenance work is being performed, ask that only certified original spare parts be used.